

Article number: 2310307331ESD

Description: E+G Antistatic base for levelling elements
LV.A-60-14-AS-M12x98-ESD-C

Measures

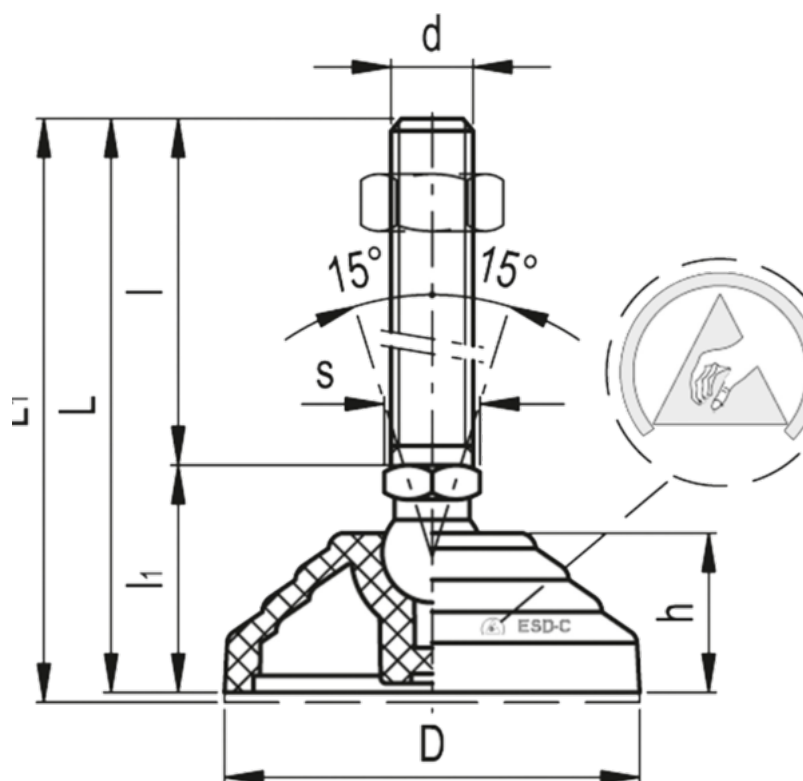

Articulation = 14	Max load = 14000
D = 60	s = 14
d = M12	Weight in (g) = 138
h = 24	
l = 98	
L1 = 33	
L = 131	
L1 = 134	